

规格说明: Specifications:

电气特性: Electrical:

- 1. 额定电流: Current Rating
1.5A/contact terminal
- 2. 额定电压: Voltage Rating
30V DC
- 3. 接触阻抗: Contact Resistance
30 milliohms MAX
- 4. 耐电压: Dielectric Withstanding Voltage:
500 V AC AT Sea Level
- 5. 绝缘阻抗: Insulation Resistance:
1000MEGA ohms MIN

物理性能: Mechanical:

- 1. 插拔力: Connector Mate and Unmate Force
Mate force: 3.57kgf (MAX)
Unmate force: 1.02kgf (MIN)
- 2. 端子保持力: Terminal Retention
1.2kgf (MIN)

原材料: Material:

- 1. 塑胶: Housing:
Hing Temperature Thermoplastics,
UL 94V-0 PBT White/Black
- 2. 端子: Contact: Copper Alloy C2680
- 3. 外壳: Shell: Copper Alloy C2680/SPCC

电镀: Finish:

- 1. 端子: Contact: Plated Gold in Mating Area;
Tin On Solder Tails
- 2. 外壳: Shell:
Nickel Plating

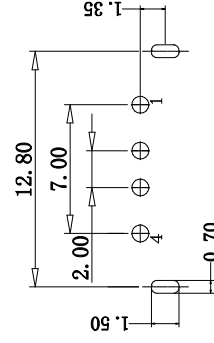
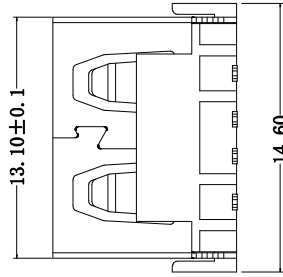
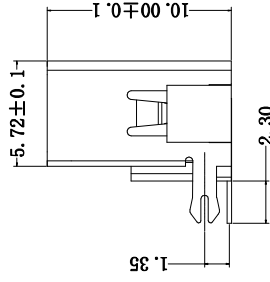
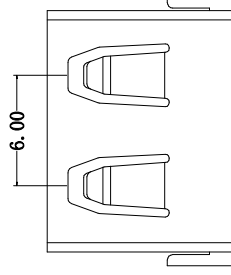
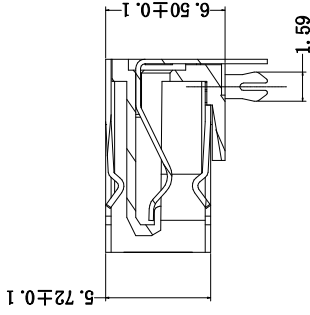

P.C.B LAYOUT

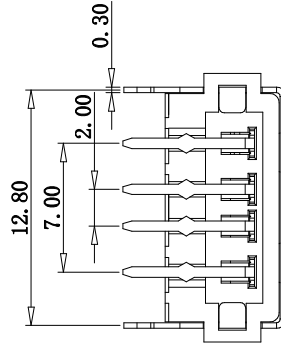

深圳市虹康科技有限公司

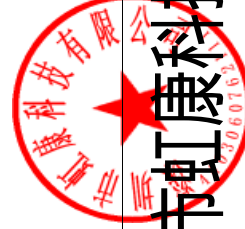

品名 (ITEM NO)	A/F 短体10.0 DIP (后两脚无卷边H=6.5)
料号 (PART NO)	SHK-20094
型号 (MODEL NO)	A008-1N-2

图号 (DWG NO)		单位 (UNIT): MM
版本 (REV)	A/0	比例 (SCALE) 1:1
日期 (DATE)		公差 (TOLERANCE) UNSPECIFIED
设计 (DESIGN)		未注公差 (TOLERANCE UNSPECIFIED)
审核 (CHECKED)		X.X ±0.30
核准 (APPROVED)		X.XX ±0.20
		X.XXX ±0.10
		X° ±5°
		X.X° ±2°